



Copak terminals and terminal blocks

IP2X

Patented

The Copak terminal is the European reference for the connection of street lighting installations.

With its unique and patented design, it guarantees the effective connection of reliable and secure installations.

Quick and flexible installation.

Easy to maintain.

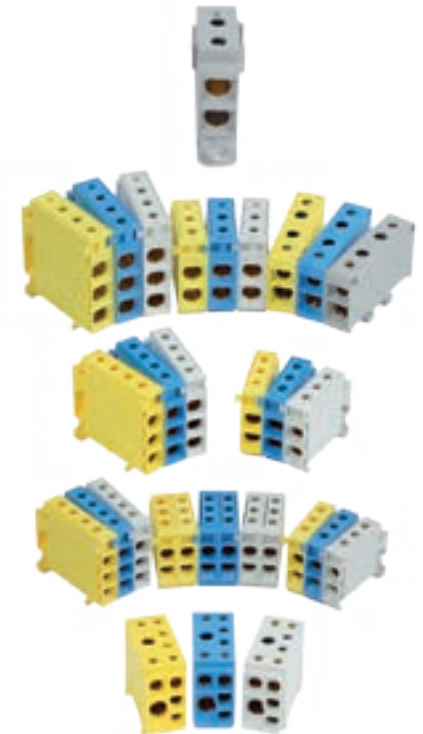
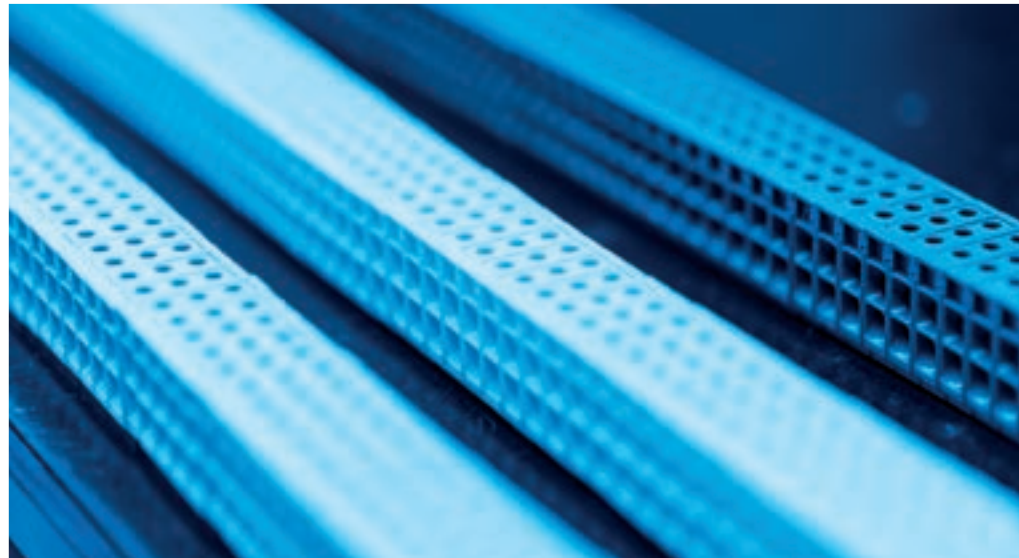

ADVANTAGES

One-piece junction block with solid brass screw and body.

One housing per conductor, individual tightening of the conductors, for quality and durable connections.

Extensive range, for all types of connection: 2 to 5 network cables, 1.5 to 50mm².

TECHNICAL CHARACTERISTICS

Solid brass one-piece body and screw.
Mounted onto 35mm DIN rail.

IP2X polyamide casing in accordance with EN 60529.

- Self-extinguishing.

Electrical specification:

- Voltage: 400V.
- Current: 150A.
- Insulation: 4.5kV.

Operating temperature: -40°C to +130°C.

Aluminium cables option:

- Tinned terminals (body and screws).

Product standards:

- EN 60947-7-1.

Installation standards:

- NF C 17-200.

Standard colours: 



One housing and one screw per conductor.

Solid brass screw and housing.

OPERATION

Connection:

- Highly durable tightening in outdoor conditions.
- One housing and one screw per conductor.
- Solid brass block and screw (see recommendation UTE C15-520), for more durable clamping and contact over time.
- Optimal contact area.
- High resistance to corrosion over time.

Installation:

- Housing in line with the conductors, intended to absorb conductor's ovalisation.
- Locking tab to facilitate tightening.
- Widened wires insertion-cones.
- Conductors of different sections can be connected in the same terminal.
- Captive screws.
- Tightening with Allen key.

Maintenance:

- The characteristic of the conductor is preserved every time it is tightened/loosened.
- Every conductor can be disconnected individually for testing or modification, while leaving the other conductors connected.
- Optional: snap-on conductors marking.

ARCHITECTURE OF A COPAK TERMINAL

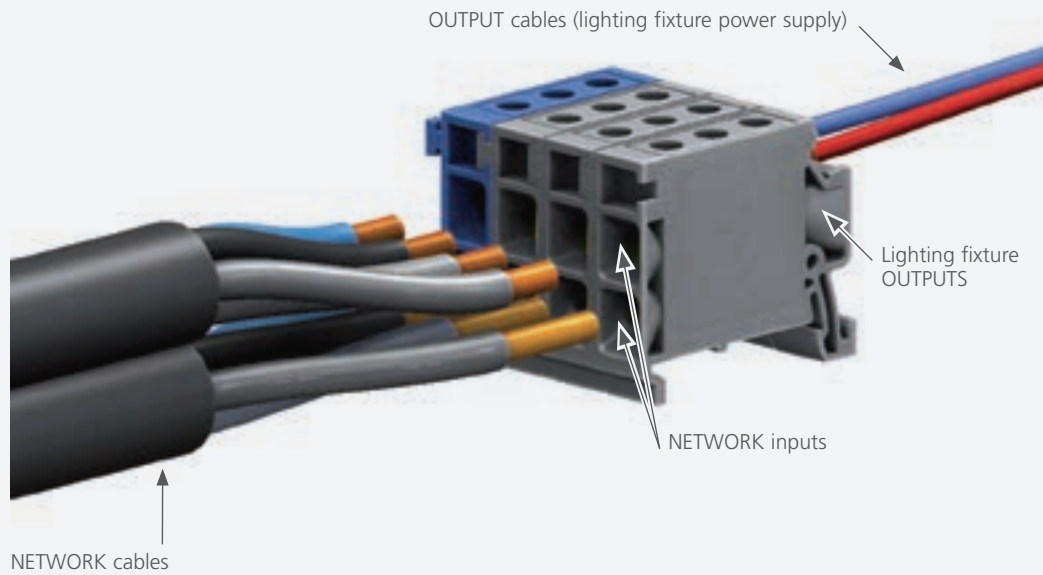

Example: assembly of 4 BD2 terminals to connect 2 network cables (4 conductors)

HOW TO INTERPRET THE DESIGNATION OF A TERMINAL

BD2

Number of NETWORK inputs of the terminal

NETWORK cable cross-section accepted

- G = NETWORK input $\leq 4\text{mm}^2$
- E = NETWORK input $\leq 10\text{mm}^2$
- D = NETWORK input $\leq 16\text{mm}^2$
- C = NETWORK input $\leq 25\text{mm}^2$
- B = NETWORK input $\leq 35\text{mm}^2$
- A = NETWORK input $\leq 50\text{mm}^2$

B=Terminal





Copak terminals - configuration support

			BD2	BD3	BD4	BD5	BC2	BC3	BB2	BB3	BBT	BA2	
			16 mm ²		16 mm ² /35 mm ²		25 mm ²		35 mm ²		16 mm ² /35 mm ²	50 mm ²	
			Recommended connection	Rigid cable derogation									
CONNECTION	NETWORK	1.5 - 16mm ²	1.5 - 25mm ²	2 inputs T3 (2.5 Nm)	3 inputs T3 (2.5 Nm)	4 inputs T3 (2.5 Nm)	4 inputs T3 (2.5 Nm)	-	-	-	-	1 input T3 (2.5 Nm)	-
		2.5 - 25mm ²	2.5 - 35mm ²	-	-	-	-	2 inputs T3 (3 Nm)	3 inputs T3 (3 Nm)	-	-	-	-
		4 - 35mm ²		-	-	-	1 input T4 (3.5 Nm)	-	-	2 inputs T4 (3.5 Nm)	3 inputs T4 (3.5 Nm)	1 input T4 (3.5 Nm)	-
		10 - 50mm ²		-	-	-	-	-	-	-	-	-	2 inputs T5 (3.5 Nm)
	Lighting fix. OUTPUT	1.5 - 16mm ²		1 output T3 (2.5 Nm)	1 output T3 (2.5 Nm)	2 outputs T3 (2.5 Nm)	2 outputs T3 (2.5 Nm)	1 output T3 (2.5 Nm)	1 output T3 (2.5 Nm)	1 output T3 (2.5 Nm)	1 output T3 (2.5 Nm)	1 output T3 (2.5 Nm)	1 output T3 (2.5 Nm)
		4 - 35mm ²		-	-	-	-	-	-	-	-	1 output T4 (3.5 Nm)	-
DIMENSIONS	L (mm)		10.1	10.1	18.1	22	11.7	11.7	14.4	14.4	15	21	
	P (mm)		39	49	39	50	45	58	50	64	43	55	
	H (mm)		43	53	43	50	46	55	45	55	62	51	
MOUNTING													
			35mm DIN rail	35mm DIN rail	35mm DIN rail	35mm DIN rail	35mm DIN rail	35mm DIN rail	35mm DIN rail	35mm DIN rail	35mm DIN rail	Specific rail	Screwed

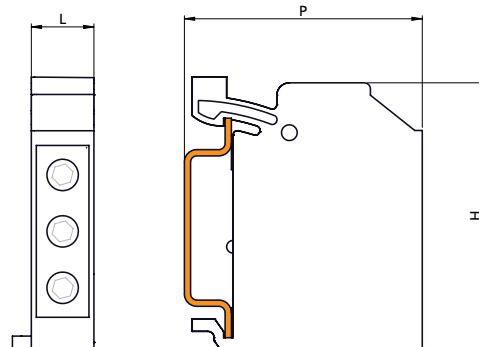
Tightening of the screws with Allen key.
T= size of the key (recommended tightening in Nm)



Copak terminal blocks - configuration support

			BE2 terminal block	BE3 terminal block	BD2 terminal block	BD3 terminal block
			10mm ²		16mm ²	
		Recommended connection				
CONNECTION	NETWORK	1.5 - 10mm ²	2 to 4 x 2 inputs* T2.5 (2 Nm)	2 to 4 x 3 inputs* T2.5 (2 Nm)	-	-
		1.5 - 16mm ²	-	-	2 to 4 x 2 inputs* T3 (2.5 Nm)	2 to 4 x 3 inputs* T3 (2.5 Nm)
	Lighting fix. OUTPUT	1.5 - 10mm ²	2 to 4 outputs** T2.5 (2 Nm)	2 to 4 outputs** T2.5 (2 Nm)	-	-
		1.5 - 16mm ²	-	-	2 to 4 outputs** T3 (2.5 Nm)	2 to 4 outputs** T3 (2.5 Nm)
DIMENSIONS	L (mm)		37	39	43	43
	P (mm)		35	41	39	48
	H (mm)		37	48	43	54
MOUNTING			Integrated into the junction box	Integrated into the junction box	Integrated into the junction box	Integrated into the junction box

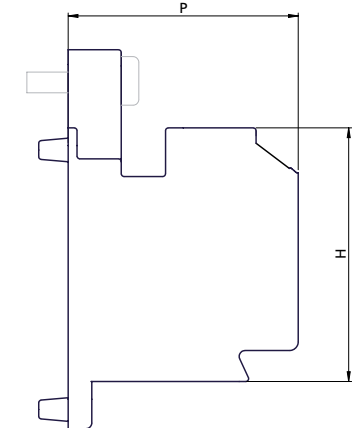
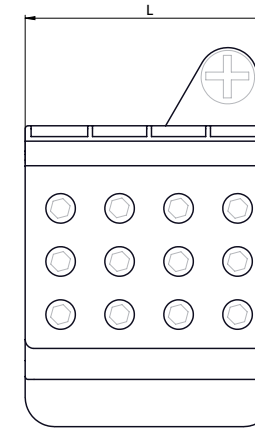

 Tightening of the screws with Allen key.
 T= size of the key (recommended tightening in Nm).
 * The total number of possible inputs varies depending on the terminal block version.
 ** The number of outputs varies depending on the terminal block version.

OTHER TERMINALS

	Junction blocks		Earth terminals		Traffic light terminals (Trafik)		Distribution terminals
	2BG1 terminal block	M and MS	TN6	TN35	D6/D10/D16 connection terminal	R2/R4	RD4
							
SECTION	2 x 2 inputs 1 - 4mm ²	2 inputs 1.5 - 4mm ² to 16mm ²	1 input 1.5 - 16mm ²	1 input 4 - 35mm ²	x inputs 1.5mm ² - 6mm ² to 16mm ²	2 to 4 inputs 2.5mm ²	4 inputs 2.5mm ²
MOUNTING	35mm DIN rail	35mm DIN rail	-	-	Screw	15mm DIN rail	35mm DIN rail